

D7500

Nikon th
100
anniversary



I AM CHASING MOMENTS



• Lens: AF-S DX NIKKOR 16-80mm f/2.8-4E ED VR • Exposure: [M] mode, 1/160 second, f/5.6 • White balance: Auto 1 • Sensitivity: ISO 500 • Picture Control: Auto • © Scott A. Woodward



• Lens: AF-S DX Micro NIKKOR 85mm f/3.5G ED VR • Exposure: [M] mode, 1/500 second, f/4.2 • White balance: Auto 1 • Sensitivity: ISO 200 • Picture Control: Auto • © Scott A. Woodward





• Lens: AF-S DX NIKKOR 18-140mm f/3.5-5.6G ED VR • Exposure: [P] mode, 1/15 second, f/8.8 • White balance: Auto 1 • Sensitivity: ISO 400 • Picture Control: Auto © Scott A. Woodward

CLASS-LEADING IMAGE QUALITY IN AN AGILE BODY

D7500



What if the superior image quality of the D500, Nikon's DX flagship D-SLR camera, was made even more accessible? The new D7500 employs the same CMOS sensor, EXPEED 5 image-processing engine and 180K-pixel RGB sensor used in the D500, but packs them into a more compact and lightweight body. It gives you total confidence when shooting under harsh lighting conditions or capturing fast and erratically moving subjects. Take your passion to the next level with the D7500.



Sharpen your creativity in more diverse scenarios

Powerful EXPEED 5 image-processing engine for superb image quality

Nikon's powerful EXPEED 5 image-processing engine handles data from the D7500's image sensor speedily, enabling the camera to achieve continuous shooting speeds of approx. 8 fps and record 4K UHD video at 30p. Noise is dramatically reduced while details are preserved, even at high ISO settings, meaning that subtle tonal gradations can be reproduced more smoothly in your images and movies.



Nikon DX-format CMOS sensor with 20.9 effective megapixels — the ideal balance between resolution and reduced noise at high sensitivities

The D7500 employs the same CMOS image sensor used in the Nikon DX flagship model D500, offering 20.9 effective megapixels. It strikes an optimal balance between image resolution and low-noise performance, delivering exceptional image quality even at high ISO settings. Designed without a low-pass filter to achieve even higher definition, it unlocks the full potential of your NIKKOR lenses, allowing the D7500 to produce amazingly sharp, crisp images.

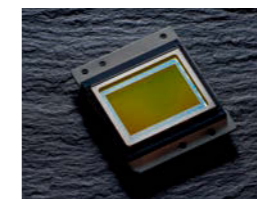

Dramatically extended shooting possibilities — standard ISO sensitivity from 100 to 51200, expandable to Hi 5 (equivalent to ISO 1640000)

The D7500 has an extremely wide ISO sensitivity range of 100 to 51200, and even at higher sensitivities it achieves consistently sharper images with lower noise. You can also lower the ISO sensitivity down to Lo 1 (ISO 50 equivalent) or raise it up to Hi 5 (ISO 1640000 equivalent). Aided by the camera's precise low-light AF performance, it's now even easier to capture subjects in dark scenes.

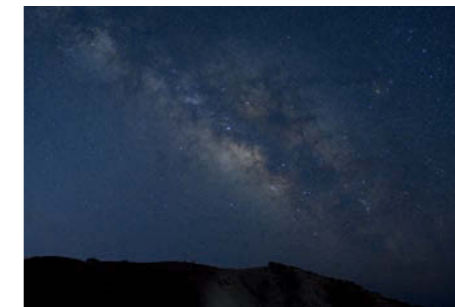

ISO 3200

Tune images just the way you want them — Picture Control system

Nikon's original Picture Control system offers an easy way to take creative control over your images. You can select one of eight Picture Controls according to your creative intentions — including Auto Picture Control, newly introduced in the D7500. If you want to give your images a more specific look, you can adjust parameters such as sharpness, clarity, contrast and brightness. It's also possible to register edited profiles as custom Picture Controls, and share the files with friends by sending them via email.



PICTURE CONTROL

Images automatically adjusted to suit each scene — Auto Picture Control

The D7500 is newly equipped with Auto Picture Control, enabling it to give your images a more desirable look according to each scene's characteristics, without the need for retouching. Using subject information precisely detected by the camera's Advanced Scene Recognition System, Auto Picture Control fine-tunes the tone curve, color, sharpness and clarity of Standard Picture Control. As a result, skin tones are rendered softer for portrait images, while blue skies and verdant greens are rendered more vibrantly for landscape shots. What's more, Auto



Auto

maintains a consistent look across multiple images when using continuous shooting, even when there are small variations in brightness or angle between each frame.

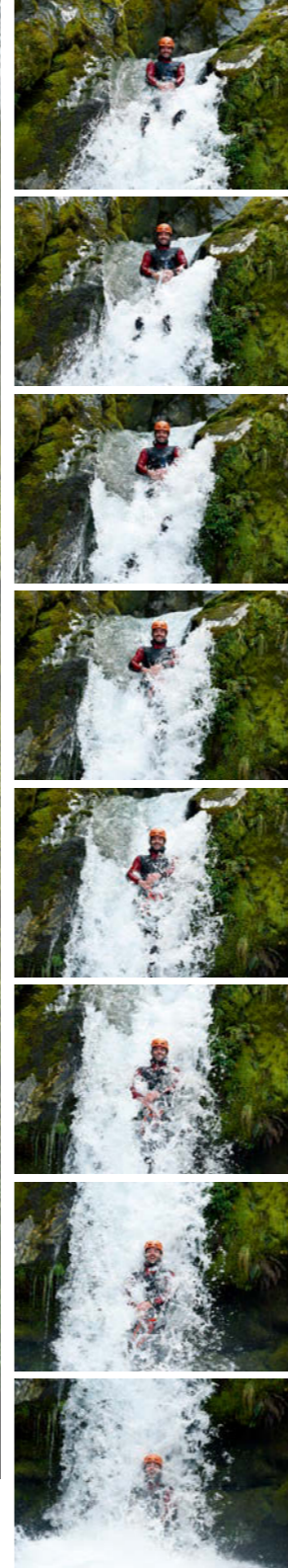

Shoot moving subjects with greater precision

Freeze the decisive moment — continuous shooting at approx. 8 fps with extended buffer capacity

Capturing fleeting moments of motion depends on the speed and duration of a camera's continuous shooting capability — and the D7500 doesn't disappoint. The rapid processing power of EXPEED 5 and an increased buffer size enable it to shoot at up to approx. 8 fps*, for approx. 50 frames (14-bit lossless compressed RAW) or 100 frames (JPEG fine, Large) at a time. The D7500's fast shooting speed and agile DX body make for a powerful combination, helping you capture subjects at their most dramatic and dynamic — even in challenging environments.

*Frame rates assume continuous-servo AF, manual or shutter-priority auto exposure, a shutter speed of 1/250 s or faster, and other settings at default values.

Acquire and maintain focus on your subject — versatile 51-point AF system

The D7500's autofocus system gives you the confidence to keep pace with fast-moving action and shoot creatively in a broad range of scenes. It employs a Multi-CAM 3500 II autofocus sensor module, with 51 focus points covering a wide area of the frame, including 15 cross-type sensors offering higher detection strength, and one center point that's compatible with f/8. The newly added group-area AF mode, highly praised by professional users, utilizes five AF points like a net to keep fast, erratically moving and low-contrast subjects in sharp focus. In auto-area AF, face detection performance is enhanced thanks to the camera's Advanced Scene Recognition System working with its 180K-pixel RGB sensor. AF detection is available down to -3 EV, making it possible to capture subjects even under low-contrast moonlight. And you can ensure even greater focusing accuracy by using the D7500's automated AF fine-tune function, which lets you adjust the precision of each of your lenses easily.



Group-area AF mode

180K-pixel RGB sensor significantly enhances Advanced Scene Recognition System

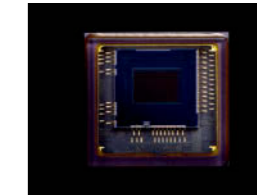

180K-pixel RGB sensor

Just like the D500, the D7500 employs a 180K-pixel RGB sensor, giving it greater command over each scene you shoot. The sensor's hugely increased pixel count enhances the accuracy of various auto controls such as autofocus, auto exposure, auto

white balance and Active D-Lighting. When using auto-area AF, it strengthens face detection performance in scenes involving smaller faces. It also underpins the D7500's new flicker reduction function, which improves consistency when shooting still images under artificial light sources.

Flicker reduction function minimizes exposure variation

Artificial light sources such as fluorescent or mercury vapor lighting tend to produce flickering, which can cause exposure variations in some of your images. The D7500's flicker reduction function for still images helps avoid this effect. It does this by detecting the peak brightness level and automatically shifting the release timing slightly, giving you stable exposures even during continuous shooting*.

*Continuous shooting speed may be decreased.

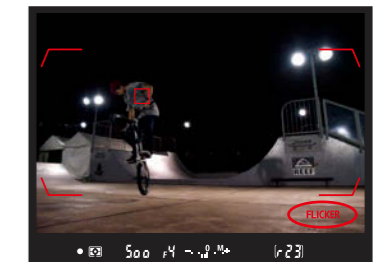

You can choose to display **FLICKER** icon in the viewfinder when flicker is detected (conceptual image shown)



Expand possibilities in a range of environments

Shoot creatively from more camera positions — touch-operation, tilting 8-cm/3.2-in. monitor

The D7500's tilting LCD monitor lets you shoot from a wider range of angles with ease, giving your creative instincts free rein. It makes macro photography from low-angle positions more convenient, and gives you a clear view of the frame when shooting night skies with the camera mounted on a tripod. The touch-panel display brings further benefits, allowing you to focus and release the shutter by touch in live view shooting, and adjust focus in video. It also permits you to review images at high speed, using the intuitive frame advance bar in playback mode.



Agile camera body with comprehensive sealing

The D7500 offers a unique balance of comfort and reliability. Its monocoque structure, made from high-stiffness carbon fiber reinforced thermoplastic, gives it a slimmer body with a deep grip that's easier to hold, while weighing just approx. 640 g/1 lb 6.6 oz (body only). Comprehensive weather sealing is applied to the camera body to prevent dust and water droplets from damaging the internal components, for added peace of mind.



Long battery life lets you explore your passion for photography uninterrupted

The D7500 manages power efficiently, so you can stay focused on your shooting without having to worry about changing batteries. Approx. 950 shots* are available on a single charge of the new EN-EL15a Rechargeable Li-ion Battery. Video recording is possible for approx. 80 min*. An optional EH-5c AC Adapter (with EP-5B Power Connector) can also be used as a power source for longer shoots.



EN-EL15a Rechargeable Li-ion Battery

*Based on CIPA Standards.

Durable shutter unit tested for 150,000 cycles



The D7500 was designed with continuous shooting speed in mind, but it's also built to last. Its shutter unit has been rigorously tested for 150,000 cycles while actually loaded onto the camera to ensure a high level of durability. It's also fitted with a shutter monitor function that calculates the duration between front- and rear-curtain movements every time the shutter is released, and automatically corrects any variance.

Built-in pop-up flash extends the possibilities for lighting

When shooting in low-lit interiors or capturing a portrait at night, the D7500's built-in pop-up flash comes in handy. Its intelligent i-TTL flash control uses detailed scene analysis by the 180K-pixel RGB sensor to add just the right amount of flash each time. Optically controlled Advanced Wireless Lighting is available for up to two groups of remote units* using the built-in flash as a commander, letting you add depth and drama to images by lighting subjects from off-camera positions. But that's not all. Used in conjunction with Nikon's WR-R10 Wireless Remote Controller, the built-in flash can also control up to three groups of optional SB-5000 Speedlights simultaneously via radio. Wireless lighting with radio control expands the creative possibilities even further, letting you fire flash units even when they're out of view, behind obstacles or in bright sunlight. Advanced Wireless Lighting using both optical (up to two groups) and radio control (up to three groups) at the same time is also possible with the D7500. It empowers you to get even more ambitious with the way you control light — and the results will speak for themselves.

*SB-5000, SB-700, SB-500 and SB-R200 (all optional).





Get your creative world in motion

High-quality 4K UHD video

The D7500 lets you record up to 29 min. 59 s in sumptuous 4K UHD/30p or Full HD video. And that's not all: movies can be recorded in MP4 as well as the conventional MOV format, allowing easy playback on smart devices. Harnessing the superior optical performance of NIKKOR lenses, the D7500 depicts scenes in breathtaking detail. Its powerful EXPEED 5 image-processing engine renders movies with low noise while maintaining sharpness, even at high ISO sensitivities. Shooting in Flat Picture Control gives you greater flexibility over color grading in post-production. It's also possible to record uncompressed, 8-bit 4:2:2 4K UHD files to an external recording device via HDMI output, while simultaneously recording to the in-camera SD memory card.

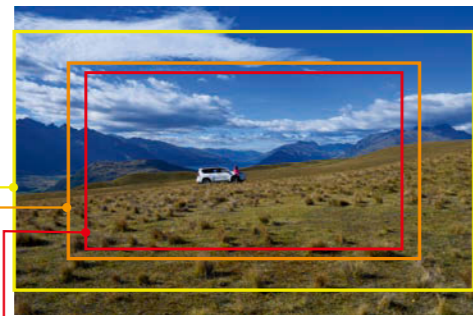

3840 × 2160: Compatible with 4K UHD
 1.3x-based image area: Compatible with Full HD and HD
 DX-based image area: Compatible with Full HD and HD
 Note: Aspect ratio of movies is 16:9 regardless of the selected image area.

Depict the passage of time dramatically — 4K UHD time-lapse movie

Time-lapse movies transform scenes of slow-moving clouds or the flow of a crowded city intersection into dramatic, high-speed sequences. The D7500 lets you generate 4K UHD* or Full HD time-lapse movies entirely within the camera. Its exposure smoothing function reduces unwanted flicker effects by automatically decreasing the slight exposure variance between frames when shooting with an auto exposure mode such as aperture-priority, in a situation like the transition between darkness and light at sunrise or sunset. Exposure smoothing is also available for interval timer shooting, which can record up to 9,999 shots.

*Maximum recording duration of 4K UHD time-lapse movie is 3 min.

Stabilize your handheld video shooting for Full HD and HD — electronic Vibration Reduction

When shooting movies handheld in Full HD or HD, the D7500's electronic Vibration Reduction function* reduces the effects of camera shake in the horizontal, vertical and rotational directions (centering on the lens). It makes it easier to capture smooth footage in situations where it isn't possible to use a tripod, or when using a single-focal-length lens without optical VR. Used together with NIKKOR's optical VR technology, the benefits are even more pronounced.

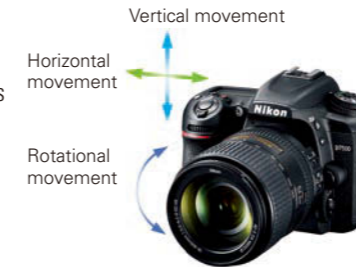

*Angle of view is slightly reduced when DX is selected for image area.

Active D-Lighting available for Full HD and HD videos

Active D-Lighting preserves details in highlights and shadows when shooting high-contrast scenes, giving your footage richer tonal gradation and a more natural brightness. Thanks to EXPEED 5, it can be applied to both Full HD and HD movies. It comes in handy when you need to use footage straight from the camera, without making post-production adjustments.



Dedicated movie menu for efficient workflow in both stills and videos

The D7500's video functions have been designed for multimedia users, who move back and forth between video and still shooting. The camera offers a dedicated movie menu that lets you change settings such as white balance and Picture Control independently of the ones used for still photography. Because you don't need to adjust your settings again, you can switch between movies and still images quickly. For added convenience, pressing the **i** button during movie live view or movie recording gives instant access to detailed video settings.

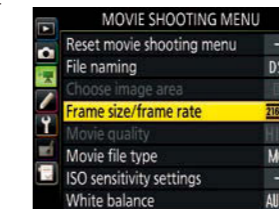

Smooth aperture control during movie recording

The D7500 is the first D7000-series camera to allow aperture control during movie recording. Its power aperture function* makes it possible to change the aperture smoothly and quietly using the multi selector while you're recording. This convenient feature means you can change the depth of field continuously, letting you vary the amount of background or foreground blur according to your creative intentions.

*Exposure mode A and M only. Operational sound may be picked up when using the internal microphone. External microphone use recommended.

Highlight display helps avoid overblown highlights

Blown-out highlights are generally undesirable in still images, but they can create much bigger problems in video. To ensure the best results when shooting movies, the D7500 has a handy feature that uses "zebra" patterns to indicate areas at risk of overexposure. This can be quickly accessed via the **i** button.



Versatile sound controls

The D7500 has a built-in stereo microphone and is compatible with the optional ME-1 Stereo Microphone and ME-W1 Wireless Microphone. Microphone sensitivity levels can be adjusted in 20 increments while visually monitoring the sound level indicator during movie recording, and it's possible to monitor using commercially available stereo headphones as well. You can also set the audio frequency response: "Wide range" is ideal for capturing a broad array of frequencies, such as the bustle of a city street, while "Vocal range" is optimized for recording human speech. Wind noise reduction is also available when using the built-in microphone.



Handy, water-resistant ME-W1 Wireless Microphone (optional)



ME-1 Stereo Microphone (optional) attached to the D7500

Explore new horizons in still and video shooting

Speed up post-production editing — in-camera RAW batch processing

The D7500 is the first Nikon D-SLR to offer in-camera RAW batch processing — an invaluable function when you need to process large numbers of RAW images, for instance when using interval timer shooting to create a time-lapse movie. It is also now possible to process images while retaining the parameters for white balance, Picture Control, high ISO NR, vignette control and Active D-Lighting that were used when shooting each image. This can greatly shorten post-production time compared to using a computer.

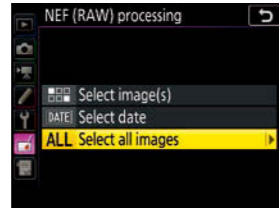

Enhanced creativity in multiple exposures



The D7500 gives you greater control when making images with the camera's multiple exposure function, making it easier to fulfill your creative vision. It's possible to combine up to 10 images using options including "Lighten" and "Darken," but the D7500 also lets you save all the single frames alongside the composite image. For still-life images, you can now view a partially overlaid preview of the final composite during the shooting process, as well

as seeing the individual exposures. If you aren't happy with the most recent frame, you can delete it and reshoot to achieve your desired effect.

An easy way to give your images a unique look — Special Effect modes

The D7500 incorporates a number of visual effects that can be applied instantly to make your stills or videos more eye-catching. In live view shooting, the effects are displayed in real time, allowing you to see what the captured image will look like. Special Effects on the D7500 include night vision, super vivid, pop, photo illustration*¹, toy camera effect, miniature effect*², selective color, silhouette, high key and low key.



*¹ Movies shot in this mode play back like a slide show made up of a series of stills.
*² Movies shot in this mode play back at high speed.

NIKKOR lenses unlock the full imaging potential of the D7500

NIKKOR lenses are trusted and praised by professionals and advanced amateurs all over the world. Drawing on a wealth of accumulated Nikon technology, they ensure high resolution even in the peripheral areas of the frame, exceptional rendering of point light sources, and beautiful image blur that conveys a natural sense of depth. NIKKOR lenses truly bring out the full potential of the D7500.

100
million
NIKKOR



• Lens: AF-S DX NIKKOR 10-24mm f/3.5-4.5G ED • Exposure: [A] mode, 10 seconds, f/14 • White balance: Auto 1 • Sensitivity: ISO 200
• Picture Control: Auto © Scott A. Woodward

AF-S DX NIKKOR 10-24mm f/3.5-4.5G ED

Explore the extremes of photography with the ultra-wide-angle coverage of this practical zoom lens. With the widest end of 15 mm*¹ covering a 109° angle of view, it delivers dramatic perspectives to give your photography a creative edge. Close-up shooting capability and minimized distortion further add to its appeal.



AF-S DX NIKKOR 16-80mm f/2.8-4E ED VR

A remarkably lightweight 5× normal zoom lens with a maximum aperture of f/2.8 at the maximum wide-angle position. This high-performance lens adopts the latest technologies, such as Nano Crystal Coat, fluorine coat and electromagnetic diaphragm — all firsts for a DX-format lens. Vibration Reduction (VR) provides an effect equivalent to a shutter speed 4.0 stops*² faster in NORMAL mode. With excellent rendering and superior mobility, it's a versatile travel companion.



AF-S DX NIKKOR 18-140mm f/3.5-5.6G ED VR

The powerful, approx. 7.8× zoom of this lens covers a broad focal-length range from wide-angle to telephoto. Its superb optical performance produces spectacular high-definition images. Vibration Reduction (VR) provides an effect equivalent to a shutter speed 4.0 stops*² faster, effectively compensating for camera shake. It's ideal for capturing diverse scenes of everyday life, or when traveling with a single lens.



AF-S DX Micro NIKKOR 85mm f/3.5G ED VR

Compact and lightweight, this lens also incorporates Vibration Reduction (VR) with an effect equivalent to a shutter speed 3.0 stops*² faster, which enables steadier handheld shooting. With a great working distance and focusing capability from infinity to life-size (1×), it gives you amazing sharpness and background bokeh for close-up subjects, portraits, nature images and more.



AF-S NIKKOR 300mm f/4E PF ED VR

This telephoto lens is the first in the NIKKOR lineup to employ a PF (Phase Fresnel) lens element, achieving an outstandingly compact and light body while effectively minimizing chromatic aberration. An ED glass element and Nano Crystal Coat further ensure high optical performance. Vibration Reduction (VR) provides an effect equivalent to a shutter speed 4.5 stops*² faster in NORMAL mode. It's ideal for capturing a wide range of subjects, from sports to wildlife and landscapes.



*¹ 35mm-format equivalent.

*² Based on CIPA Standards. The value is achieved when: DX-format lenses are attached to a DX-format digital SLR camera, FX-format compatible lenses are attached to an FX-format digital SLR camera, and zoom lenses are set at the maximum telephoto position.



• Lens: AF-S NIKKOR 35mm f/1.8G ED • Exposure: [M] mode, 1/250 second, f/8 • White balance: Auto 1
• Sensitivity: ISO 100 • Picture Control: Auto © Scott A. Woodward

Radio-controlled Advanced Wireless Lighting using versatile, high-output Nikon SB-5000 Speedlight



The SB-5000 is the first Nikon Speedlight that can be controlled via radio, pushing the boundaries of wireless multi-flash shooting. With the WR-R10 Wireless Remote Controller attached to the D7500 as a commander, Advanced Wireless Lighting is available for up to six groups of SB-5000s, even when they're out of view, behind obstacles or in bright ambient light. Advanced Wireless Lighting using both light and radio is possible with the D7500

as well, while the SB-5000 can also be used to control up to three groups via light. The SB-5000's cooling system prevents the flash panel from overheating when shooting consecutive bursts. As a result, it can fire continuously for longer than conventional models, without flash cool-down time between bursts, while maintaining a powerful output at the guide number of 41m/134.5 ft*.

*ISO 100, at 35 mm zoom head position, in DX format, standard illumination pattern.



With the WR-R10 attached to the D7500 as a commander, three SB-5000 Speedlights are triggered wirelessly via radio.



Share your most impressive images easily — built-in Bluetooth® and Wi-Fi® connectivity

The pleasure of a beautiful image becomes even greater when you share the experience with others. The D7500 can maintain a constant connection to a smart device* with the SnapBridge application installed (available as a free download), via Bluetooth®. You can automatically transfer the images you take to your smart device, upload them automatically to NIKON IMAGE SPACE, and use the smart device to browse images stored in the camera. You can also embed those images with location and date/time information from your smart device. Using Wi-Fi®, it's possible to transfer images and movies by selecting the files in the app, as well as control shooting remotely. SnapBridge dramatically enhances the experience of taking and sharing images with a digital SLR camera.

*Compatible with iPhone®, iPad®, iPod touch® or smart devices running on the Android™ operating system.

Note: The camera's built-in Wi-Fi® capability can only be used when the SnapBridge app is installed on a compatible smart device.



Still images and movie management software — ViewNX-i (free download)

ViewNX-i is Nikon's free software for browsing and editing JPEG, RAW and movie files, as well as RAW files edited with Capture NX-D. It incorporates ViewNX-Movie Editor, which can be used to edit movies, including 4K UHD footage. Access to various web services is also available.



RAW image-processing software with auto retouch brush — Capture NX-D (free download)

Capture NX-D, Nikon's free software for processing its original RAW (NEF/NRW) files, comes with an auto retouch brush that lets you remove dust spots on an image easily. It can also be used to adjust parameters such as exposure compensation, white balance, Picture Control and unsharp mask. JPEG and TIFF files are also compatible.



Remote control software with extended features — Camera Control Pro 2 (optional)

Camera Control Pro 2 lets you remotely control the camera from a computer via wired or wireless connection. It supports Windows 64-bit (native) and is compatible with the advanced functions included in the D7500, allowing you to enable/disable flicker reduction during still shooting, and turn Active D-Lighting for movies and electronic VR on/off. In-camera editing of IPTC information is also possible. You can use shortcuts to control settings such as exposure mode, exposure compensation, shutter speed and aperture. Interval timer shooting in bulb mode is also supported, for more flexibility in remote shooting.

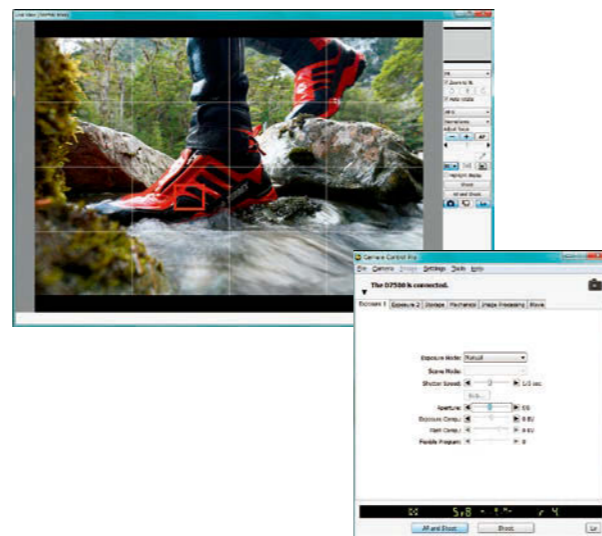

PARTS AND CONTROLS

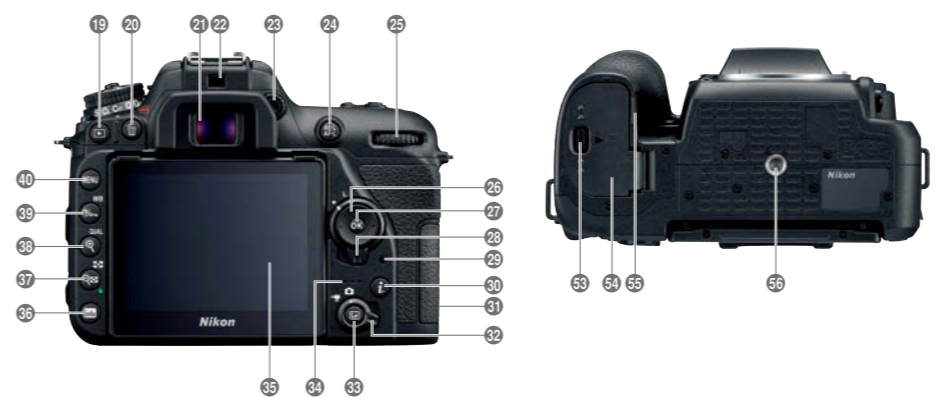
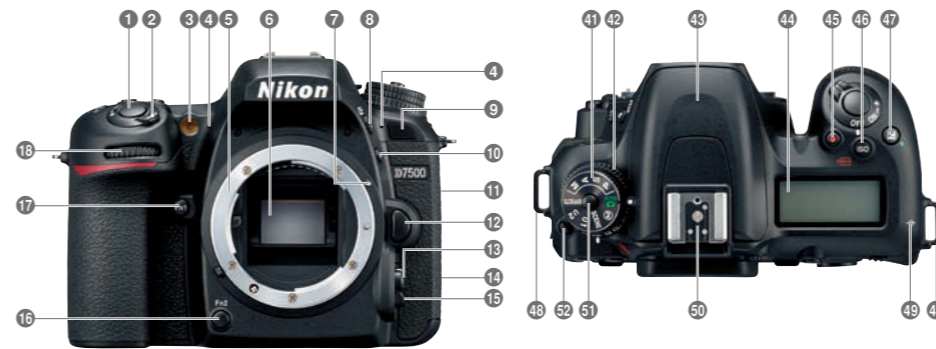

- 1 Shutter-release button
- 2 Power switch
- 3 AF-assist illuminator/Self-timer lamp/Red-eye reduction lamp
- 4 Stereo microphone
- 5 Lens mount
- 6 Mirror
- 7 Lens mounting mark
- 8 Flash mode button/Flash compensation button
- 9 Infrared receiver
- 10 Bracketing button
- 11 Cover for USB, HDMI and external microphone connectors
- 12 Lens release button
- 13 AF-mode button
- 14 Cover for accessory terminal and headphone connector
- 15 Focus-mode selector
- 16 Fn2 button
- 17 Fn1 button
- 18 Sub-command dial
- 19 Playback button
- 20 Delete button/Format button
- 21 Viewfinder eyepiece
- 22 Eye sensor
- 23 Diopter adjustment control
- 24 AE/AF lock button
- 25 Main command dial
- 26 Multi selector
- 27 OK button
- 28 Focus selector lock
- 29 Memory card access lamp
- 30 \mathcal{Z} button
- 31 Memory card slot cover
- 32 Live view selector
- 33 Live view button
- 34 Speaker
- 35 Tilting monitor
- 36 Battery-chamber cover
- 37 Battery-chamber cover latch
- 38 Accessory shoe (for optional flash unit)
- 39 Mode dial lock release
- 40 Release mode dial lock release
- 41 Battery-chamber cover
- 42 Battery-chamber cover latch
- 43 Tripod socket
- 44 Playback zoom in button/Image quality/size button
- 45 Help button/White balance button
- 46 Menu button
- 47 Mode dial
- 48 Release mode dial
- 49 Built-in flash
- 50 Control panel
- 51 Movie-record button
- 52 ISO sensitivity button/Format button
- 53 Exposure compensation button
- 54 Eyelet for camera strap
- 55 Focal plane mark
- 56 Accessory shoe (for optional flash unit)

SYSTEM CHART

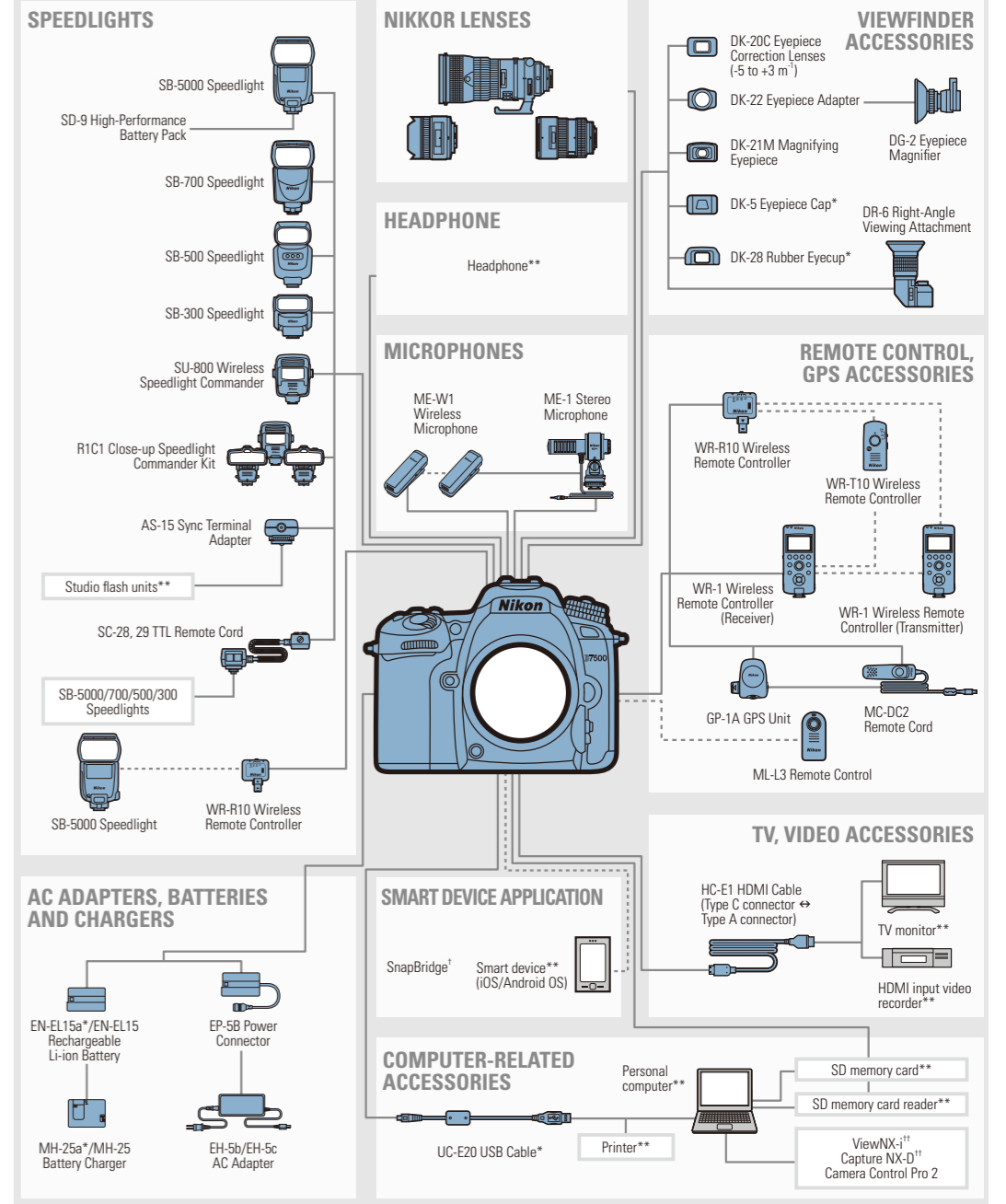

*Supplied accessories **Non-Nikon products † Can be downloaded from the application store of each smart device (free). †† Can be downloaded from Nikon website (free).

